

B1=B2  
ESC. 1:25

B1=B2  
ESC. 1:25

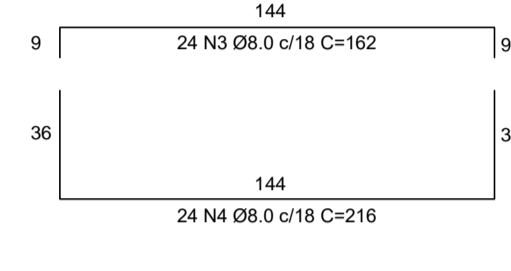
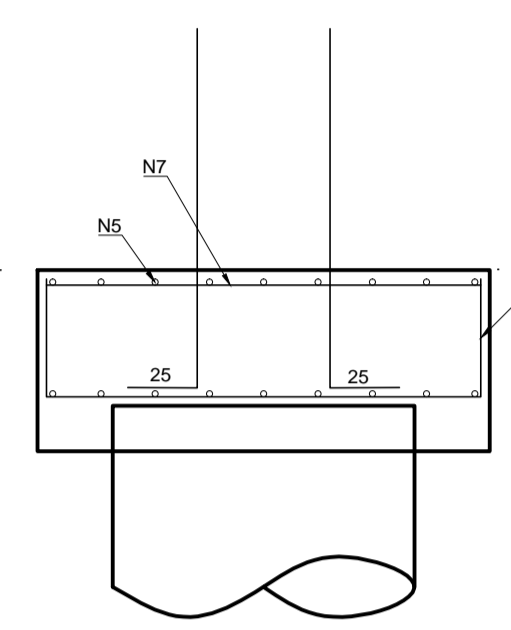

Relação do aço

CAÇO	N	DIAM	Q	UNIT (cm)	C TOTAL (cm)
CA50	1	8.0	20	Var.	2619
CA50	2	8.0	20	Var.	3699
CA50	3	8.0	24	162	3888
CA50	4	8.0	24	216	5184
CA50	5	8.0	20	Var.	2619
CA50	6	8.0	20	Var.	3699
CA50	7	8.0	7	Var.	2513
CA50	8	8.0	7	Var.	2702
CA50	9	8.0	9	510	4590
CA50	10	8.0	9	510	4590
CA50	11	8.0	7	Var.	2513
CA50	12	8.0	7	Var.	2702
CA50	13	8.0	5	789	3945
CA50	14	8.0	5	531	2655
CA50	15	8.0	5	510	2550
CA50	16	8.0	5	789	3945
CA50	17	10.0	30	Var.	11288
CA50	18	8.0	19	531	10089
CA50	19	10.0	44	441	19404
CA50	20	10.0	30	Var.	11288
CA50	21	8.0	14	709	9926
CA50	22	8.0	4	Var.	1516
CA50	23	8.0	16	510	8160
CA50	24	8.0	4	Var.	1516
CA50	25	8.0	14	709	9926
CA50	26	12.5	4	754	3016
CA50	27	10.0	4	754	3016
CA50	28	10.0	20	754	15080
CA50	29	12.5	10	754	7540
CA60	30	5.0	126	168	21168
CA50	31	8.0	6	348	2088
CA50	32	10.0	9	304	2736
CA60	33	5.0	60	108	6480
CA50	34	8.0	54	435	23490
CA50	35	10.0	54	156	8424
CA50	36	10.0	54	156	8424
CA50	37	10.0	81	435	35235
CA50	38	8.0	29	815	23635
CA50	39	10.0	29	815	23635
CA50	40	10.0	108	110	11880
CA50	41	12.5	108	190	20520
CA50	42	6.3	12	794	9528
CA50	43	6.3	10	794	7940

Resumo do aço

CAÇO	DIAM	C TOT (m)	PESO (Kg)
CA50	6.3	174,68	43,32
CA50	8.0	1447,59	570,59
CA50	10.0	1504,1	938,56
CA50	12.5	310,76	307,03
CA60	5.0	276,48	42,58
PESO TOTAL			
CA50		1859,50	
CA60		42,58	

Vol. de concreto total (C-15) = 14,98 m³  
Vol. de concreto total (C-25) = 48,00 m³  
Área de forma total = 231,06 m²

V1=V2  
ESC. 1:50

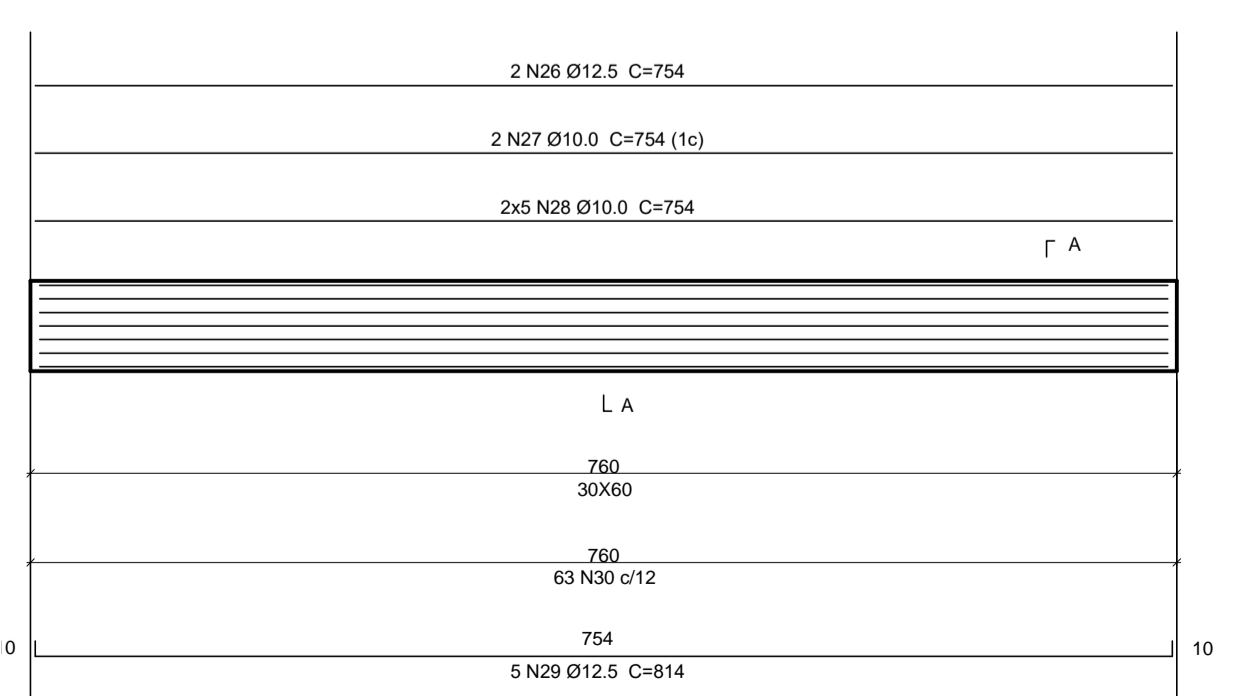

SEÇÃO A-A  
Esc. 1:25

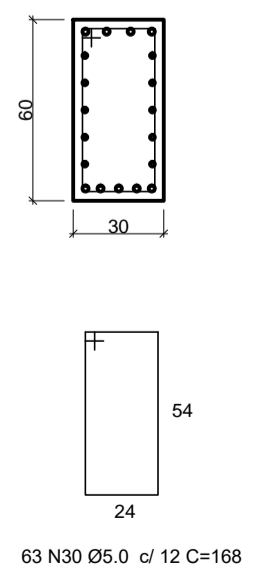

V3=V4=V5  
ESC. 1:50

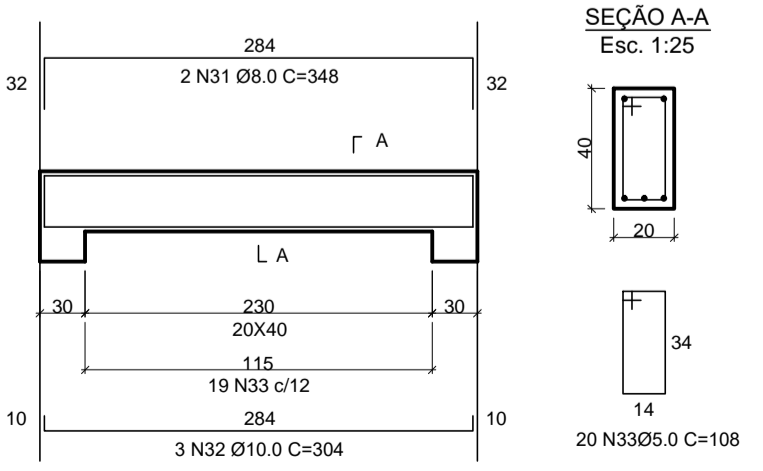

SEÇÃO A-A  
Esc. 1:25

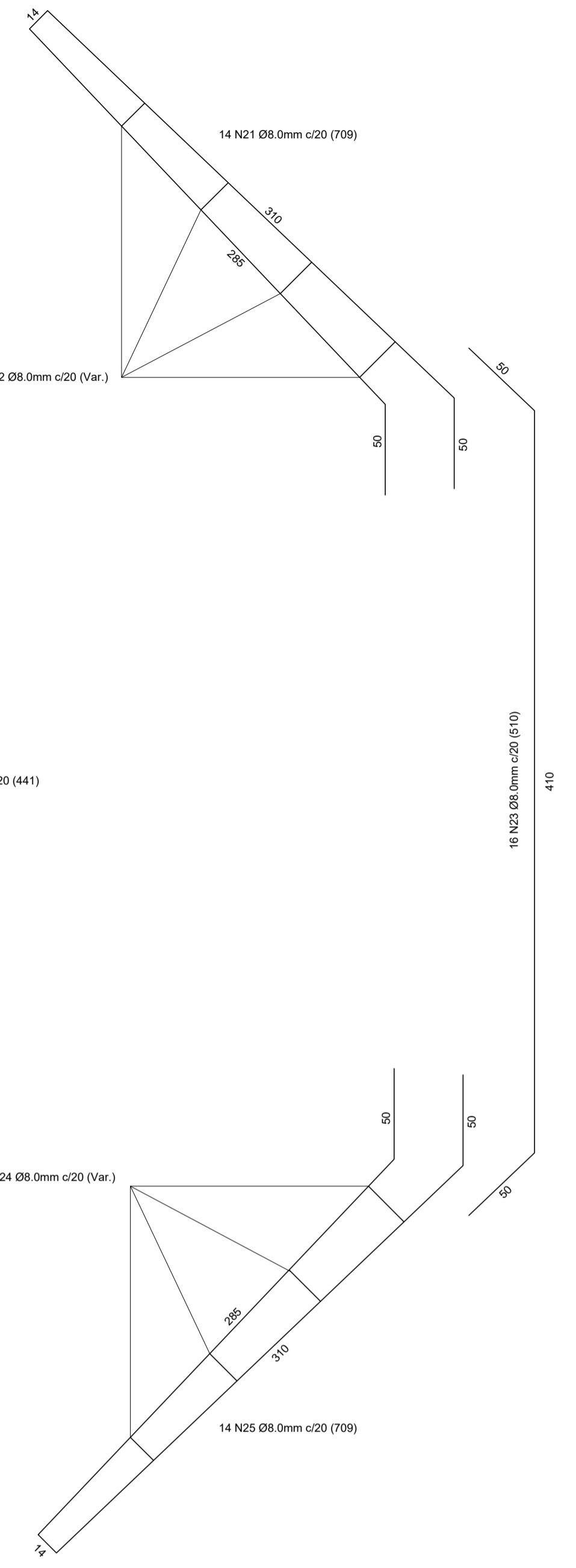
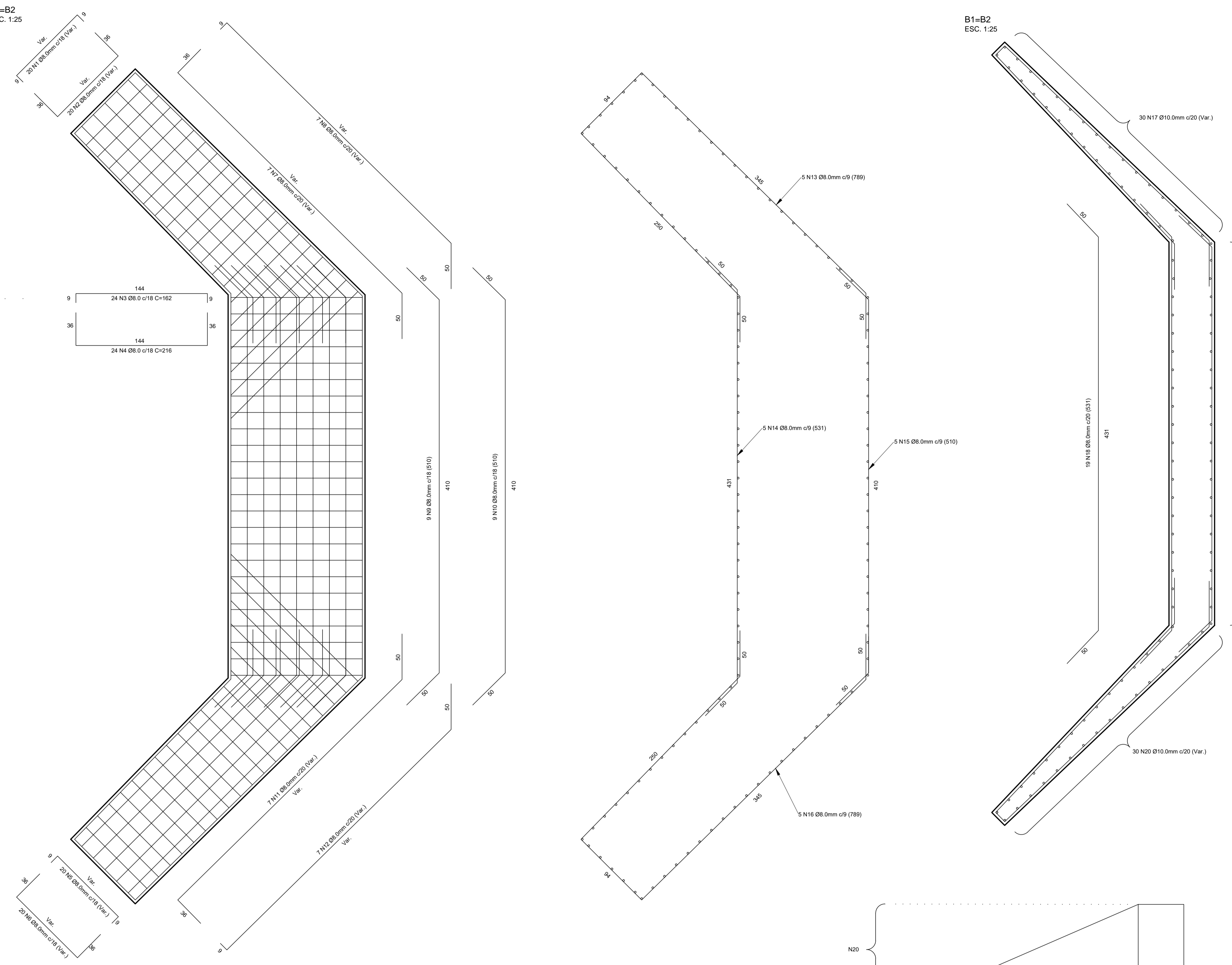
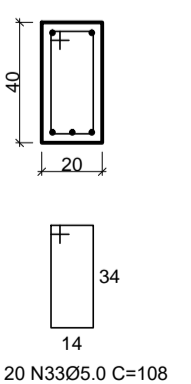

PROJETO ESTRUTURAL

EDIFICACAO	ÁREA TOTAL CONSTRUÍDA : 33,60 M <sup>2</sup>	
	PROPRIETÁRIO: PREFEITURA MUNICIPAL DE SÃO JOÃO DO PARAÍSO MÔNICA CRISTINE MENDES DE SOUSA – PREFEITA MUNICIPAL	
PROJETO	R.T.: MARCOS ALVES CAMARGO JUNIOR CREA/MG: 194.932/D	
	TÍTULO PROJETO ESTRUTURAL	
	USO VIÁRIO	
	END. OBRA: DISTRITO DE BARRINHA, ZONA RUARAL DE SÃO JOÃO DO PARAÍSO-MG	
DETALHE	Detalhamento de armação. ART n° 5.534.986 Convênio 862222/2017	
	DATA	JANEIRO 2020
	FOLHA	05 / 06